



CUSTOM CONCRETE SINK WITH BASIN MODEL RC-1812-S

SINK BASIN LIBRARY

Our in-house collection of sink basin molds

EDITION: 29.APR.2021

 **Trueform**
concrete

ANATOMY OF A SINK

What Trueform refers to as a *sink* is a 3-dimensional object defined by 3 features:

1. the **counter** or **deck** (flat surface on top that defines entire area)
2. the **sink basin** (opening in the counter or deck)
- 3 the **apron** (edge, or perceived thickness).

Because concrete can be cast into complex structures and shapes, our fabricators can create a counter/deck and a sink basin that is a single, seamless piece of concrete. This is referred to as an **integral sink**.

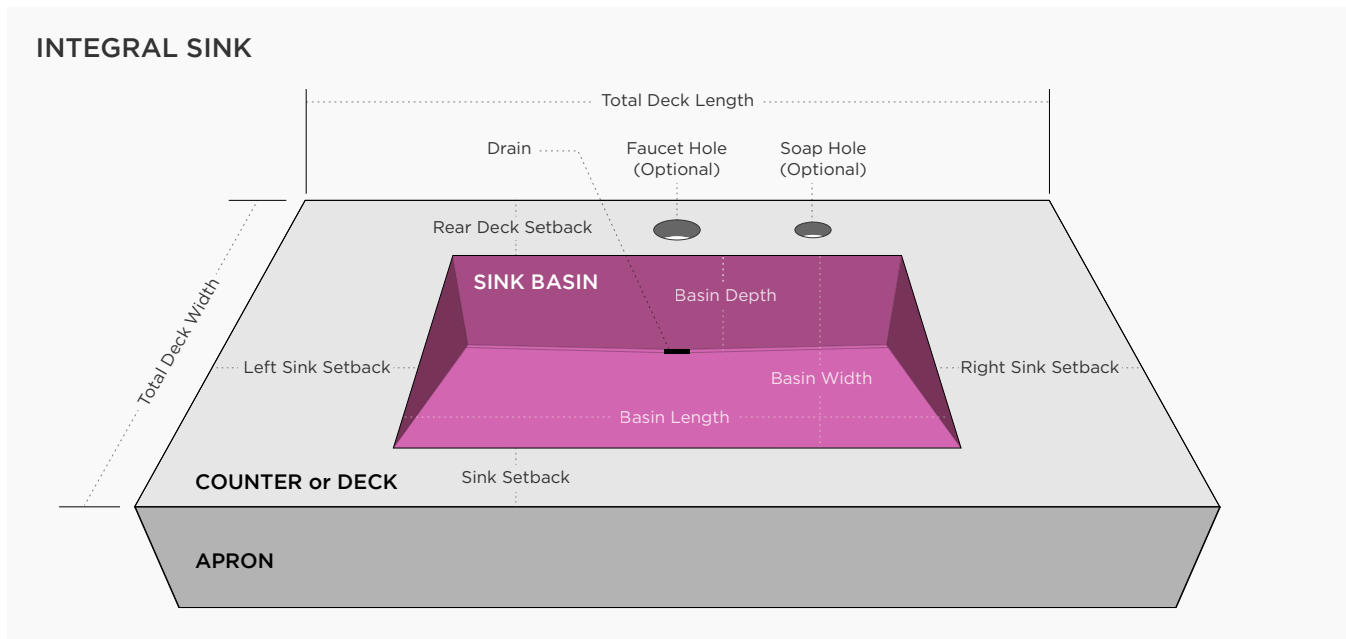

SINK BASIN

A **sink basin** is defined as the entire bowl or opening in the counter that captures water and moves it to the drain. Whether we are creating a standard or custom sink, our fabricators need to incorporate separate mold(s) of the specified sink basin(s) within the larger, overall mold for the deck and apron.

While the mold that defines the deck is relatively easy to modify, **sink basin molds** are objects with fixed dimensions that we reuse for multiple projects. Having sink basin molds available enables us to reduce waste while minimizing the overall project lead time. It also enables us to offer custom sinks at a lower overall cost versus creating entirely new (custom) basin molds for each project.

Trueform has amassed an extensive library of sink basin molds which should be able to satisfy the requirements of most custom sink projects. We offer a range of popular sink basin shapes and sizes—ranging from 14” long to over 120” long. This document describes our in-house collection of basins in terms of their overall style, length, width, depth and drain type.









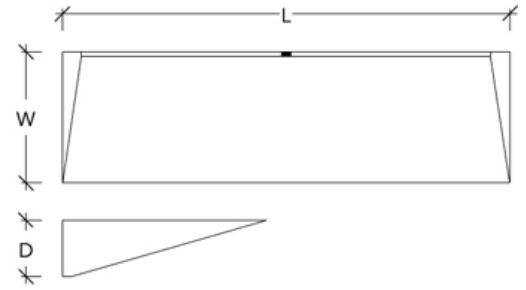











While beyond the scope of this document, Trueform can also create **fully custom or build-to-spec sink basin molds**. While the result is a sink that is truly unique, it invariably adds time, cost and complexity to the project. For more information on custom sink basin molds, please contact a Trueform Sink Specialist at 888-474-7977 / info@trueformconcrete.com.

RAMP BASINS

Ramp basins feature a front face that angles down from the deck to a narrow trough at the rear that pitches toward a small opening called a slot drain.

These sinks are ADA compliant when installed as per guidelines.



Model	L Length	W Width	D Depth	Drain Type	Certification
R-1410	14	10	5	Slot Drain	
R-1812	18	12	5.25	Slot Drain	
R-1813-S	18	13	3	Slot Drain	
R-2013	20	13	5	Slot Drain	
R-2413	24	13	5	Slot Drain	
R-3013	30	13	5	Slot Drain	
R-3016	30	16	5	Slot Drain	
R-3213	32	13	5	Slot Drain	
R-3613	36	13	5	Slot Drain	
R-3916.5	39	16.5	5.5	Slot Drain	
R-4813	48	13	5	Slot Drain	
R-6013	60	13	5	Slot Drain	
R-7213	72	13	5	Slot Drain	
R-8012	80	12	5	2 Slot Drains	
R-8412	84	12	5	2 Slot Drains	
R-8413	84	13	5	2 Slot Drains	
R-9013.5	90	13.5	5	2 Slot Drains	
R-9612	96	12	5	2 Slot Drains	
R-11012	110	12	5	2 Slot Drains	
R-11415	114	15	5	2 Slot Drains	
R-2812-SS*	28	12	5	Slot Drain	

*Side-Mounted Ramp Sink

PARADIGM BASIN

Paradigm basins feature a front face that angles down from the deck to a wider trough at the rear that pitches toward a larger opening called a grid drain.

These sinks are ADA compliant when installed as per guidelines.

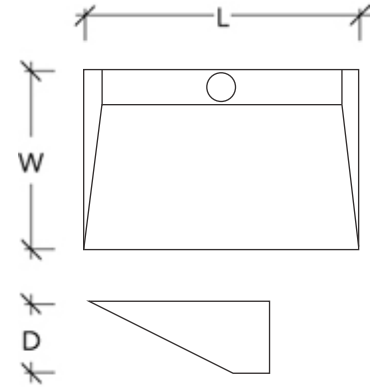









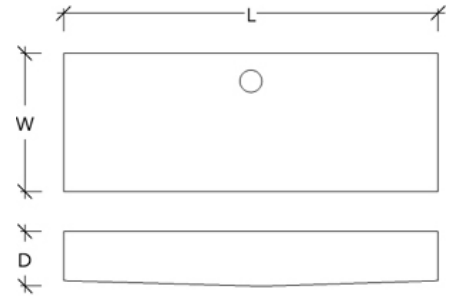





Model	L Length	W Width	D Depth	Drain Type	Certification
PARADIGM	20	13	5	Grid Drain	

RECTANGLE BASINS

Rectangle basins are just that - rectangular shaped impressions that drop to a bottom that is very gradually pitched to a grid drain located toward the rear of the basin.

These sinks are ADA compliant.





Model	L Length	W Width	D Depth	Drain Type	Certification
RC-10	8.25	10	5	Grid Drain	
RC-1308	13	8.25	5	Grid Drain	
RC-1812-S	18	12	3	Grid Drain	
RC-1915-SH	19.5	15	2.5	Grid Drain	
RC-2012	20	12	5	Grid Drain	
RC-2015	20	15.75	5.5	Grid Drain	
RC-2015-SH	20	15.5	2.8	Grid Drain	
RC-2408-SH	23.625	8.625	3	Grid Drain	
RC-2416	24.25	16	6	Grid Drain	
RC-3313	33.5	13	5	2 Grid Drains	
RC-4812	48	12	5	Grid Drain	
RC-4813	48	13	4.5	Grid Drain	
RC-6615	66	15	5	Grid Drain	
RC-9612	96	12	4.5	Grid Drain	

HALF-TROUGH BASINS

Half-trough basins are similar to ramp sinks except that the transition from the front of the deck to the bottom of the basin is a curve. These basins also feature grid drains positioned to the rear of the basin.

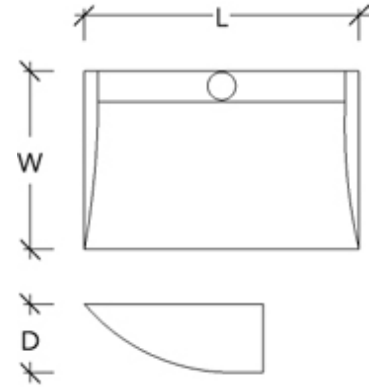
These sinks are ADA compliant.





Model	L Length	W Width	D Depth	Drain Type	Certification
HT-1614	16	14	5.5	Grid Drain	
HT-2013	20	13	5	Grid Drain	

TROUGH SINKS

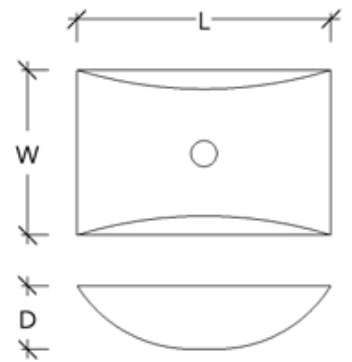
Trough sinks arc from the left and right edges down to a drain which is centered in the bottom. The front and back edges taper gradually to meet the arc. Because of the centered drain, trough sinks tend not to be ADA compliant.







Model	L Length	W Width	D Depth	Drain Type	Certification
T-2011	20	11	6	Grid Drain	
T-2814	28	14	4.5	Grid Drain	

ROUND BASINS

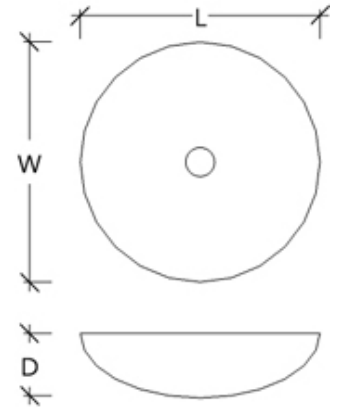
Round basins are either circular or oval-shaped bowls that slope down from all edges into a grid drain.

These may or may not be ADA compliant depending on how there are mounted.







Model	L Length	W Width	D Depth	Drain Type	Certification
OV-1515	15.25	15.25	5.5	Grid Drain	
OV-1813	18.75	13.5	4.5	Grid Drain	
OV-OS-15	15	15	3	Grid Drain	

SCOOP BASINS

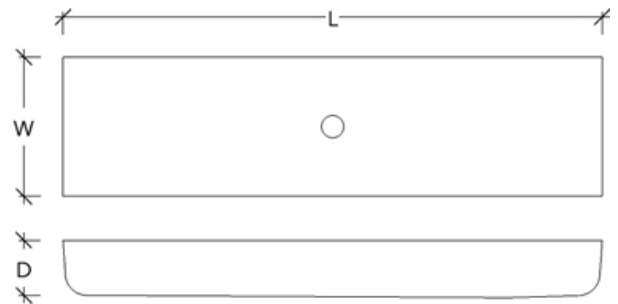
Scoop basins are similar to rectangle basins except that the bottom edges curve toward the bottom before gradually pitching into a centered grid drain.

These sinks are not ADA compliant.





Model	L Length	W Width	D Depth	Drain Type	Certification
SCP-4012	40	12.5	5.5	Grid Drain	
SCP-5414	54	14	5	Grid Drain	
SCP-6512	65.25	12	5	Grid Drain	

SUB BASINS

Sub basins feature arcs as left and right edges that sweep down to a bottom that is gradually pitched toward a centered grid drain.

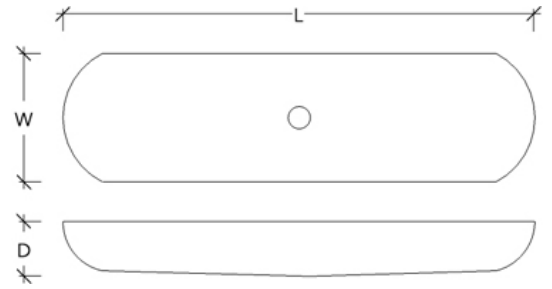
These sinks are not ADA compliant.



Model	L Length	W Width	D Depth	Drain Type	Certification
SB-4816	48	16	5	Grid Drain	
SB-4813	48.25	13	5	Grid Drain	