

PLAN VIEW

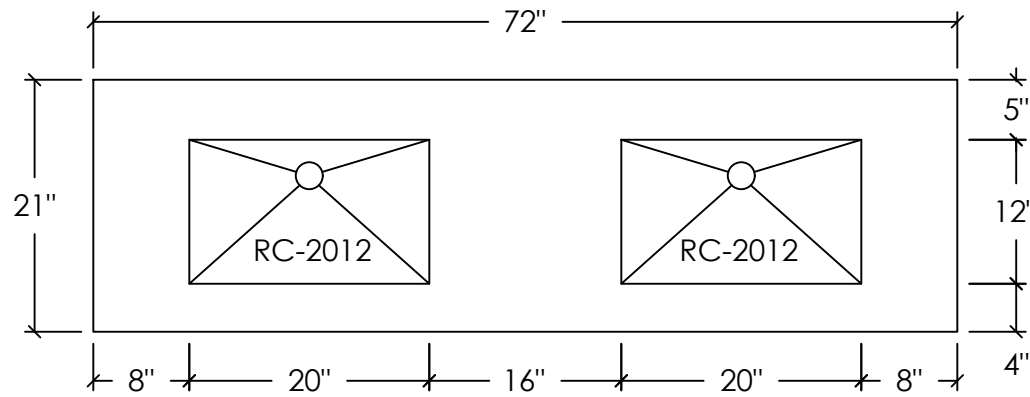

RIGHT SECTION

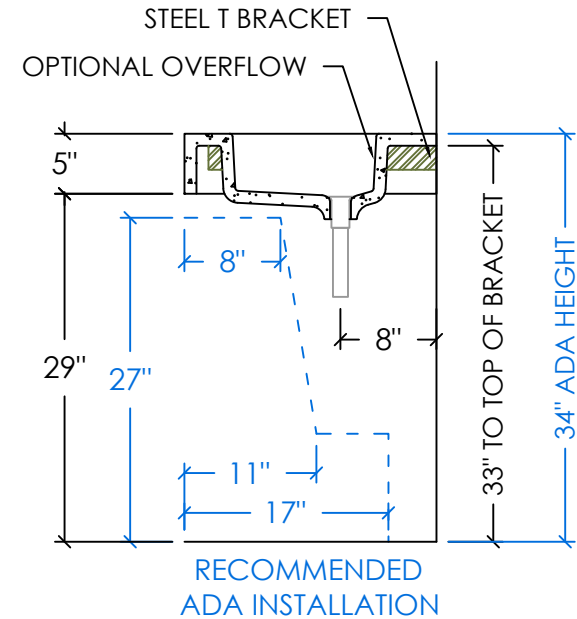

REAR ELEVATION

T BRACKET LOCATION RANGE (SEE BRACKET MOUNTING INSTRUCTIONS)

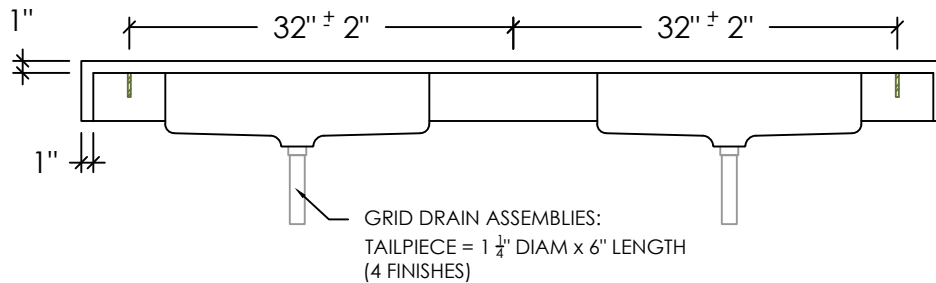

SPECIFICATIONS

SINK BASINS:

- SINK MODEL #: RC-2012 = 20" x 12" x 5 1/4"
- COMPLIANCE & CERTIFICATIONS:



CSA B45.8/IAPMO Z403
ASME A112.18.2/CSA B125.2
CODE = RC-RC-ST-2-2-72x21-(C)-(O)



ICC A117.1

STANDARD FAUCET & SOAP HOLE CONFIGURATIONS (CUSTOMIZABLE):

- 0 HOLES - WALL-MOUNT FAUCET
- 1 SINGLE FAUCET HOLE OR TRIPLE HOLE SET CENTERED ON SINK BASINS
- SOAP HOLE 5" MINIMUM TO LEFT OR RIGHT OF FAUCET HOLE
- TRIPLE HOLE SET = 8" SPREAD
- HOLE DIAMETER = 1 3/8"
- HOLE(S) CENTERED 2 1/4" OFF OF BACK OF SINK BASIN
- OPTIONAL OVERFLOW ASSEMBLY (D-OK-125) CENTERED ON REAR BASIN WALL