

PLAN VIEW

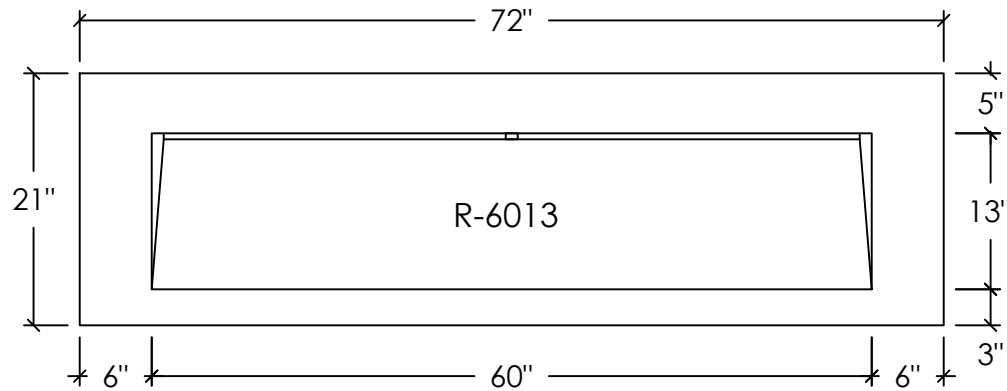

RIGHT SECTION

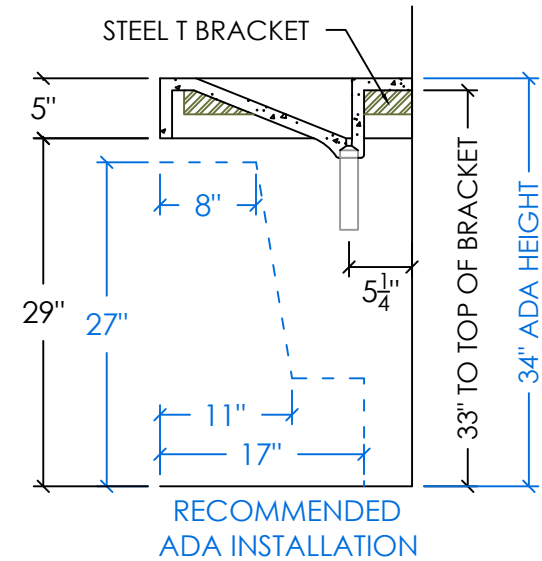

REAR ELEVATION

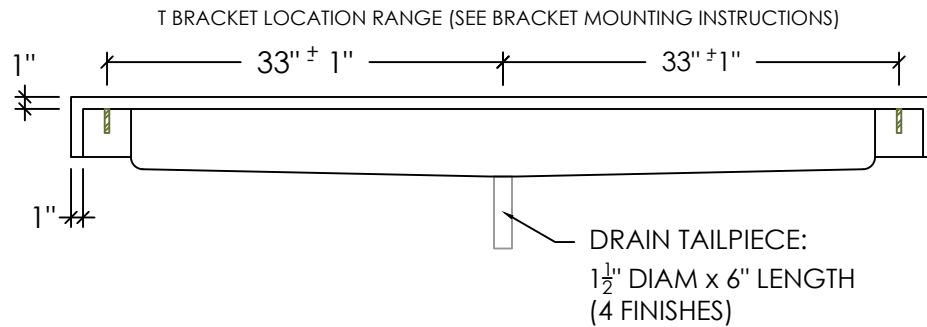

SPECIFICATIONS

SINK BASIN:

- SINK MODEL #: R-6013 = 60" x 13" x 5"
- COMPLIANCE & CERTIFICATIONS:



CSA B45.8/IAPMO Z403
ASME A112.18.2/CSA B125.2
CODE = R-SL-3-1-72x21-(C)-(O)



ICC A117.1

STANDARD FAUCET & SOAP HOLE CONFIGURATIONS (CUSTOMIZABLE):

- 0 HOLES - WALL-MOUNT FAUCET
- 2 SINGLE FAUCET HOLES OR TRIPLE HOLE SETS 36" APART (FAUCET SPOUTS 12" IN FROM SINK BASIN WALLS)
- 3 SINGLE FAUCET HOLES OR TRIPLE HOLE SETS WITH 21" SPACING (OUTSIDE FAUCET SPOUTS 6" IN FROM SINK BASIN WALLS)
- SOAP HOLE 5" MINIMUM TO LEFT OR RIGHT OF FAUCET HOLE
- TRIPLE HOLE SET = 8" SPREAD
- HOLE DIAMETER = 1 3/8"
- HOLE(S) CENTERED 2 1/4" OFF OF BACK OF SINK BASIN